

# Product datasheet

Specifications



## Logic controller, Modicon M221, 24 IO transistor PNP Ethernet

TM221CE24T

### Main

Range of product	Modicon M221
Product or component type	Logic controller
[Us] rated supply voltage	24 V DC
Discrete input number	14, discrete input 4 fast input conforming to IEC 61131-2 Type 1
Analogue input number	2 at 0...10 V
Discrete output type	Transistor
Discrete output number	10 transistor 2 fast output
Discrete output voltage	24 V DC
Discrete output current	0.5 A

### Complementary

Discrete I/O number	24
Maximum number of I/O expansion module	7 for transistor output 7 for relay output
Supply voltage limits	20.4...28.8 V
Inrush current	35 A
Maximum power consumption in W	14 W at 24 V (with max number of I/O expansion module) 4.8 W at 24 V (without I/O expansion module)
Power supply output current	0.52 A 5 V for expansion bus 0.2 A 24 V for expansion bus
Discrete input logic	Sink or source (positive/negative)
Discrete input voltage	24 V
Discrete input voltage type	DC
Analogue input resolution	10 bits
LSB value	10 mV
Conversion time	1 ms per channel + 1 controller cycle time for analogue input analog input
Permitted overload on inputs	+/- 30 V DC for 5 min (maximum) for analog input +/- 13 V DC (permanent) for analog input
Voltage state 1 guaranteed	$\geq 15$ V for input
Voltage state 0 guaranteed	$\leq 5$ V for input
Discrete input current	7 mA for discrete input 5 mA for fast input

<b>Input impedance</b>	3.4 kOhm for discrete input 100 kOhm for analog input 4.9 kOhm for fast input
<b>Response time</b>	35 µs turn-off, I2...I5 terminal(s) for input 5 µs turn-on, I0, I1, I6, I7 terminal(s) for fast input 35 µs turn-on, other terminals terminal(s) for input 5 µs turn-off, I0, I1, I6, I7 terminal(s) for fast input 100 µs turn-off, other terminals terminal(s) for input 5 µs turn-on, turn-off, Q0...Q1 terminal(s) for output 50 µs turn-on, turn-off, Q2...Q3 terminal(s) for output 300 µs turn-on, turn-off, other terminals terminal(s) for output
<b>Configurable filtering time</b>	0 ms for input 3 ms for input 12 ms for input
<b>Discrete output logic</b>	Positive logic (source)
<b>Maximum current per output common</b>	5 A
<b>Output frequency</b>	100 kHz for fast output (PWM/PLS mode) at Q0...Q1 5 kHz for output at Q2...Q3 0.1 kHz for output at Q4...Q9
<b>Absolute accuracy error</b>	+/- 1 % of full scale for analog input
<b>Maximum leakage current</b>	0.1 mA for transistor output
<b>Maximum voltage drop</b>	<1 V
<b>Mechanical durability</b>	20000000 cycles for transistor output
<b>Maximum tungsten load</b>	<12 W for output and fast output
<b>Protection type</b>	Overload and short-circuit protection at 1 A
<b>Reset time</b>	1 s automatic reset
<b>Memory capacity</b>	256 kB for user application and data RAM with 10000 instructions 256 kB for internal variables RAM
<b>Data backed up</b>	256 kB built-in flash memory for backup of application and data
<b>Data storage equipment</b>	2 GB SD card (optional)
<b>Battery type</b>	BR2032 lithium non-rechargeable, battery life: 4 year(s)
<b>Backup time</b>	1 year at 25 °C (by interruption of power supply)
<b>Execution time for 1 KInstruction</b>	0.3 ms for event and periodic task
<b>Execution time per instruction</b>	0.2 µs Boolean
<b>Exct time for event task</b>	60 µs response time
<b>Maximum size of object areas</b>	255 %C counters 512 %M memory bits 8000 %MW memory words 512 %KW constant words 255 %TM timers
<b>Realtime clock</b>	With
<b>Clock drift</b>	<= 30 s/month at 25 °C
<b>Regulation loop</b>	Adjustable PID regulator up to 14 simultaneous loops
<b>Positioning functions</b>	Position PTO 2 axe(s)pulse/direction mode (100 kHz) Position PTO 1 axe(s)CW/CCW mode (100 kHz)
<b>Function available</b>	Frequency generator PLS PWM
<b>Counting input number</b>	4 fast input (HSC mode) at 100 kHz 32 bits
<b>Counter function</b>	A/B Single phase Pulse/direction
<b>Integrated connection type</b>	USB port with mini B USB 2.0 connector Non isolated serial link serial 1 with RJ45 connector and RS232/RS485 interface Ethernet with RJ45 connector

<b>Supply</b>	(serial)serial link supply: 5 V, <200 mA
<b>Transmission rate</b>	1.2...115.2 kbit/s (115.2 kbit/s by default) for bus length of 15 m for RS485 1.2...115.2 kbit/s (115.2 kbit/s by default) for bus length of 3 m for RS232 480 Mbit/s for USB
<b>Communication port protocol</b>	USB port: USB - SoMachine-Network Non isolated serial link: Modbus master/slave - RTU/ASCII or SoMachine-Network Ethernet
<b>Port Ethernet</b>	10BASE-T/100BASE-TX 1 port with 100 m copper cable
<b>Communication service</b>	Modbus TCP slave device Modbus TCP server Modbus TCP client Ethernet/IP adapter DHCP client
<b>Local signalling</b>	1 LED (green) for PWR 1 LED (green) for RUN 1 LED (red) for module error (ERR) 1 LED (green) for SD card access (SD) 1 LED (red) for BAT 1 LED per channel (green) for I/O state 1 LED (green) for SL Ethernet network activity (green) for ACT Ethernet network link (yellow) for Link (Link Status)
<b>Electrical connection</b>	removable screw terminal block for inputs removable screw terminal block for outputs terminal block, 3 terminal(s) for connecting the 24 V DC power supply connector, 4 terminal(s) for analogue inputs Mini B USB 2.0 connector for a programming terminal
<b>Maximum cable distance between devices</b>	Shielded cable: <10 m for fast input Unshielded cable: <30 m for output Unshielded cable: <30 m for digital input Unshielded cable: <1 m for analog input Shielded cable: <3 m for fast output
<b>Insulation</b>	Between input and internal logic at 500 V AC Between fast input and internal logic at 500 V AC Non-insulated between inputs Between output and internal logic at 500 V AC Non-insulated between analogue input and internal logic Non-insulated between analogue inputs
<b>Marking</b>	CE
<b>Mounting support</b>	Top hat type TH35-15 rail conforming to IEC 60715 Top hat type TH35-7.5 rail conforming to IEC 60715 plate or panel with fixing kit
<b>Height</b>	90 mm
<b>Depth</b>	70 mm
<b>Width</b>	110 mm
<b>Net weight</b>	0.395 kg

## Environment

<b>Standards</b>	EN/IEC 61131-2 EN/IEC 61010-2-201 EN/IEC 60664-1
<b>Product certifications</b>	IACS E10 ABS EAC RCM CSA cULus LR DNV-GL
<b>Environmental characteristic</b>	Ordinary and hazardous location
<b>Resistance to electrostatic discharge</b>	8 kV in air conforming to EN/IEC 61000-4-2 4 kV on contact conforming to EN/IEC 61000-4-2
<b>Resistance to electromagnetic fields</b>	10 V/m 80 MHz...1 GHz conforming to EN/IEC 61000-4-3 3 V/m 1.4 GHz...2 GHz conforming to EN/IEC 61000-4-3 1 V/m 2...2.7 GHz conforming to EN/IEC 61000-4-3
<b>Resistance to magnetic fields</b>	30 A/m 50/60 Hz conforming to EN/IEC 61000-4-8
<b>Resistance to fast transients</b>	2 kV (power lines) conforming to EN/IEC 61000-4-4

2 kV (relay output) conforming to EN/IEC 61000-4-4  
 1 kV (I/O) conforming to EN/IEC 61000-4-4  
 1 kV (Ethernet line) conforming to EN/IEC 61000-4-4  
 1 kV (serial link) conforming to EN/IEC 61000-4-4

<b>Surge withstand</b>	2 kV power lines (AC) common mode conforming to EN/IEC 61000-4-5 2 kV relay output common mode conforming to EN/IEC 61000-4-5 1 kV I/O common mode conforming to EN/IEC 61000-4-5 1 kV shielded cable common mode conforming to EN/IEC 61000-4-5 0.5 kV power lines (DC) differential mode conforming to EN/IEC 61000-4-5 1 kV power lines (AC) differential mode conforming to EN/IEC 61000-4-5 1 kV relay output differential mode conforming to EN/IEC 61000-4-5 0.5 kV power lines (DC) common mode conforming to EN/IEC 61000-4-5
<b>Resistance to conducted disturbances</b>	10 V 0.15...80 MHz conforming to EN/IEC 61000-4-6 3 V 0.1...80 MHz conforming to Marine specification (LR, ABS, DNV, GL) 10 V spot frequency (2, 3, 4, 6.2, 8.2, 12.6, 16.5, 18.8, 22, 25 MHz) conforming to Marine specification (LR, ABS, DNV, GL)
<b>Electromagnetic emission</b>	Conducted emissions - test level: 79 dB $\mu$ V/m QP/66 dB $\mu$ V/m AV ( power lines (AC)) at 0.15...0.5 MHz conforming to EN/IEC 55011 Conducted emissions - test level: 73 dB $\mu$ V/m QP/60 dB $\mu$ V/m AV ( power lines (AC)) at 0.5...300 MHz conforming to EN/IEC 55011 Conducted emissions - test level: 120...69 dB $\mu$ V/m QP ( power lines) at 10...150 kHz conforming to EN/IEC 55011 Conducted emissions - test level: 63 dB $\mu$ V/m QP ( power lines) at 1.5...30 MHz conforming to EN/IEC 55011 Radiated emissions - test level: 40 dB $\mu$ V/m QP class A ( 10 m) at 30...230 MHz conforming to EN/IEC 55011 Conducted emissions - test level: 79...63 dB $\mu$ V/m QP ( power lines) at 150...1500 kHz conforming to EN/IEC 55011 Radiated emissions - test level: 47 dB $\mu$ V/m QP class A ( 10 m) at 200...1000 MHz conforming to EN/IEC 55011
<b>Immunity to microbreaks</b>	10 ms
<b>Ambient air temperature for operation</b>	-10...55 °C (horizontal installation) -10...35 °C (vertical installation)
<b>Ambient air temperature for storage</b>	-25...70 °C
<b>Relative humidity</b>	10...95 %, without condensation (in operation) 10...95 %, without condensation (in storage)
<b>IP degree of protection</b>	IP20 with protective cover in place
<b>Pollution degree</b>	<= 2
<b>Operating altitude</b>	0...2000 m
<b>Storage altitude</b>	0...3000 m
<b>Vibration resistance</b>	3.5 mm at 5...8.4 Hz on symmetrical rail 3.5 mm at 5...8.4 Hz on panel mounting 1 gn at 8.4...150 Hz on symmetrical rail 1 gn at 8.4...150 Hz on panel mounting
<b>Shock resistance</b>	147 m/s <sup>2</sup> for 11 ms

## Packing Units

<b>Unit Type of Package 1</b>	PCE
<b>Number of Units in Package 1</b>	1
<b>Package 1 Height</b>	11.133 cm
<b>Package 1 Width</b>	14.136 cm
<b>Package 1 Length</b>	15.607 cm
<b>Package 1 Weight</b>	621.0 g
<b>Unit Type of Package 2</b>	CAR
<b>Number of Units in Package 2</b>	20
<b>Package 2 Height</b>	29.7 cm
<b>Package 2 Width</b>	39.8 cm
<b>Package 2 Length</b>	57.0 cm
<b>Package 2 Weight</b>	13.211 kg

## Offer Sustainability

<b>Sustainable offer status</b>	Green Premium product
<b>REACH Regulation</b>	<a href="#">REACH Declaration</a>
<b>EU RoHS Directive</b>	Pro-active compliance (Product out of EU RoHS legal scope) <a href="#">EU RoHS Declaration</a>
<b>Mercury free</b>	Yes
<b>China RoHS Regulation</b>	<a href="#">China RoHS declaration</a>
<b>RoHS exemption information</b>	<a href="#">Yes</a>
<b>Environmental Disclosure</b>	<a href="#">Product Environmental Profile</a>
<b>Circularity Profile</b>	<a href="#">End of Life Information</a>
<b>WEEE</b>	The product must be disposed on European Union markets following specific waste collection and never end up in rubbish bins
<b>PVC free</b>	Yes

Dimensions

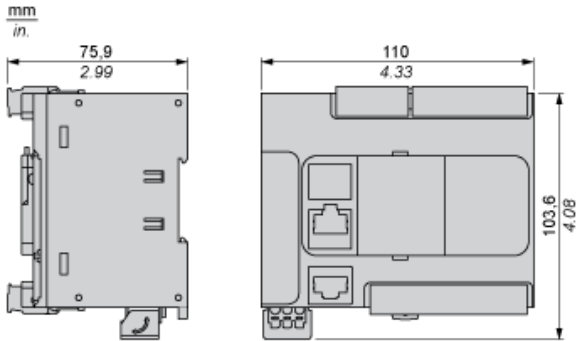

**Mounting on a Rail**

---

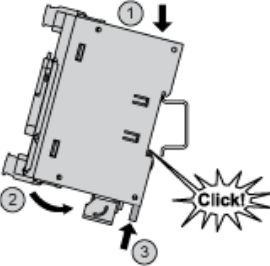

**Direct Mounting on a Panel Surface**

---



(1) Install a mounting strip

**Mounting Hole Layout**

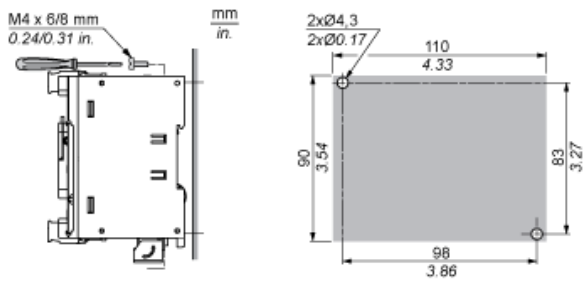



**Mounting**

---

**Correct Mounting Position**



**Acceptable Mounting Position**



**Incorrect Mounting Position**

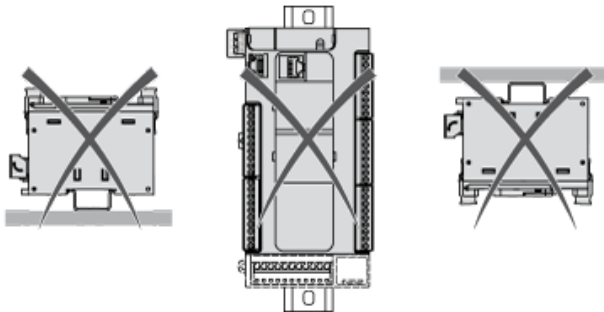

Clearance

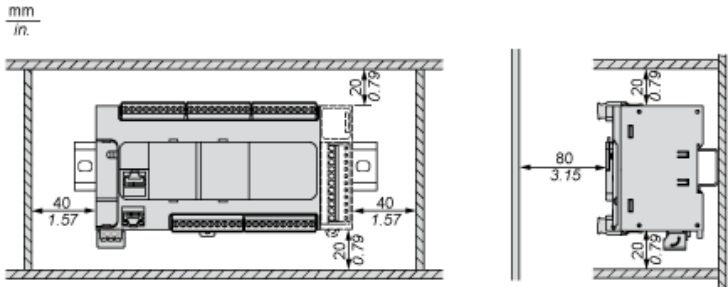

Digital Inputs

---

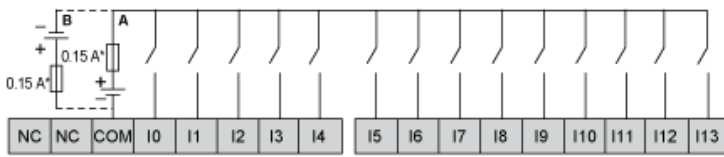

- (\*) Type T fuse
- (A) Sink wiring (positive logic).
- (B) Source wiring (negative logic).

Connection of the Fast Inputs

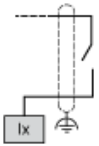

I0, I1, I6, I7

Transistor Outputs

---

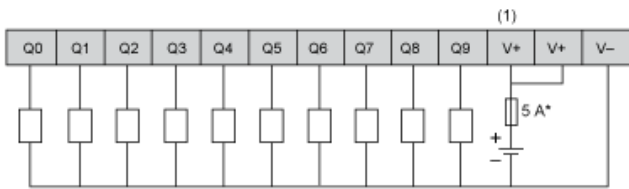

- (\*) Type T fuse
- (1) The V+ terminals are connected internally.

Connection of the Fast Outputs

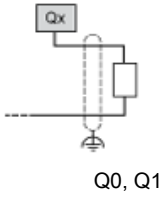

**Analog Inputs**

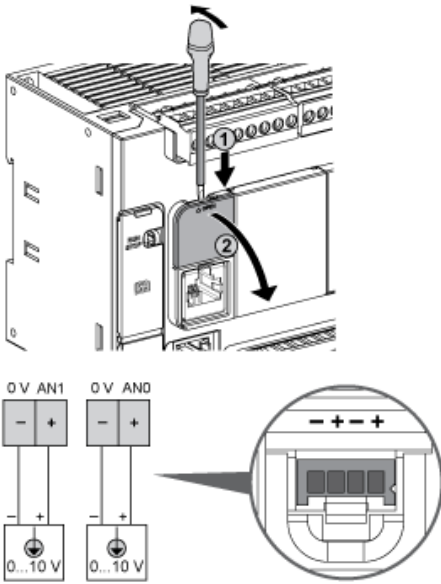

The (-) poles are connected internally.

Pin	Wire Color
0 V	Black
AN1	Red
0 V	Black
AN0	Red

**Ethernet Connection**

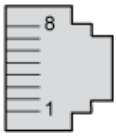

Pin N°	Signal
1	TD+
2	TD-
3	RD+
4	-
5	-
6	RD-
7	-
8	-

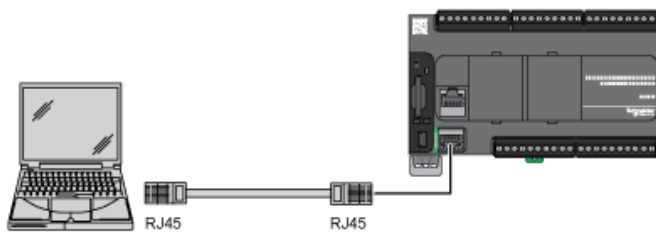

## USB Mini-B Connection

---

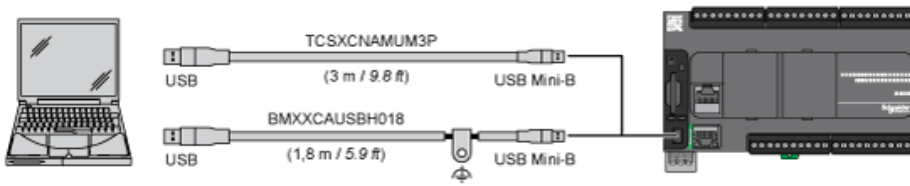

**SL1 Connection**



SL1

N °	RS 232	RS 485
1	RxD	N.C.
2	TxD	N.C.
3	RTS	N.C.
4	N.C.	D1
5	N.C.	D0
6	CTS	N.C.
7	N.C.*	5 Vdc
8	Common	Common

N.C.: not connected

\* : 5 Vdc delivered by the controller. Do not connect.

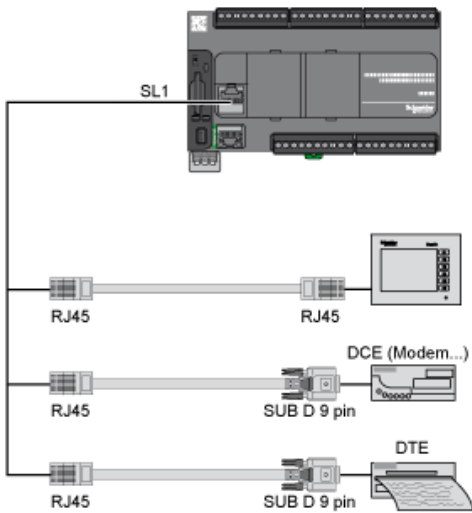



**Derating Curves**

---

**Embedded Digital Inputs (No Cartridge)**

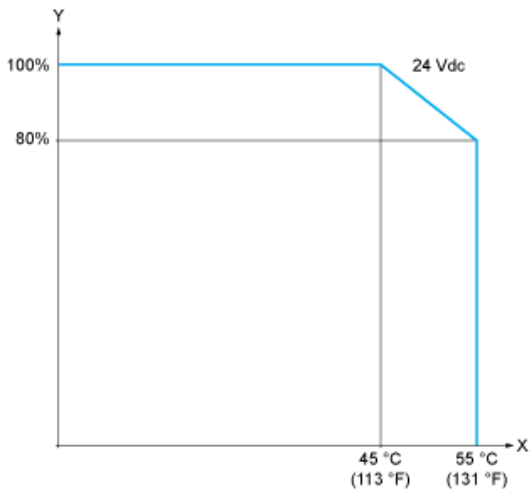

X : Ambient temperature  
Y : Input simultaneous ON ratio

**Embedded Digital Inputs (with Cartridge)**

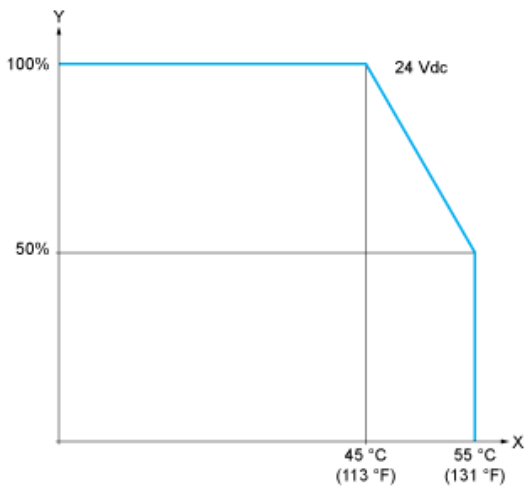

X : Ambient temperature  
Y : Input simultaneous ON ratio

**Derating Curves**

---

**Embedded Digital Outputs (No Cartridge)**

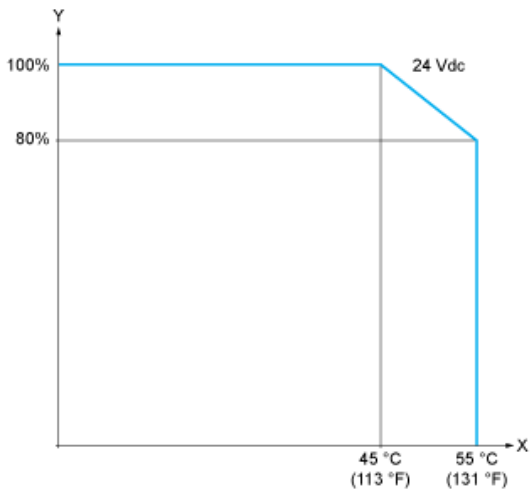

X : Ambient temperature  
Y : Output simultaneous ON ratio

**Embedded Digital Outputs (with Cartridge)**

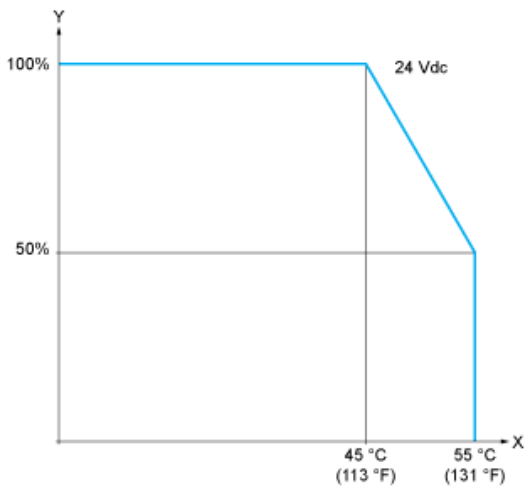

X : Ambient temperature  
Y : Output simultaneous ON ratio

**Recommended replacement(s)**