



ⓘ Discontinued

Main

Range of product	Modicon ABE7
Product or component type	Electromechanical output relay sub-base
[Us] rated supply voltage	24 V DC for PLC end
Number of channels	16
Connections - terminals	Spring terminal, 1 x 0.09...1 x 1.5 mm ² (AWG 28...AWG 16) flexible with cable end Spring terminal, 1 x 0.14...1 x 2.5 mm ² (AWG 26...AWG 12) solid Spring terminal, 1 x 0.14...1 x 2.5 mm ² (AWG 26...AWG 14) flexible without cable end

Complementary

Terminal block type	Removable
Supply voltage limits	30 V DC (PLC end)
Polarity distribution	Volt-free
Protection type	Internal fuse 1 A 5 x 20 mm fast blow PLC end Adjustable by external fuse high breaking capacity preactuator end
Fixing mode	By clips (35 mm symmetrical DIN rail) By screws (solid plate with fixing kit)
Width	206 mm
Maximum current per output common	10 A
Current per channel	5 A for preactuator end
Minimum switching current	10 mA at ≥ 5 V
Drop-out voltage	2.4 V at 20 °C (PLC end)
Switching frequency	≤ 10 Hz ≤ 0.5 Hz
Threshold tripping voltage	19.7 V at 40 °C
Drop-out current	1 mA at 20 °C
Maximum power dissipation per channel in W	0.36 W (PLC end)
Contacts type and composition	1 NO for preactuator end
Maximum switching voltage	250 V AC 50/60 Hz conforming to IEC 60947-5-1

Disclaimer: This documentation is not intended as a substitute for and is not to be used for determining suitability or reliability of these products for specific user applications.

30 V DC conforming to IEC 60947-5-1

Electrical durability	500000 cycles, maximum switching current: 600 mA at 24 V DC-13 10 ms (preactuator end) 500000 cycles, maximum switching current: 1500 mA at 230 V AC-12 (preactuator end) 500000 cycles, maximum switching current: 1500 mA at 24 V DC-12 (preactuator end) 500000 cycles, maximum switching current: 900 mA at 230 V AC-15 (preactuator end)
Electrical reliability	1e-008
Operating time	<= 10 ms coil energisation and NO closing <= 5 ms coil de-energisation and NO opening
Contact bounce time	<= 5 ms 1 NO
Operating rate in Hz	10 Hz no load 0.5 Hz at Ie
Mechanical durability	20000000 cycles
[Uimp] rated impulse withstand voltage	IEC 60947-1 2.5 kV
[Ui] rated insulation voltage	2000 V
Installation category	II conforming to IEC 60664-1
Tightening torque	0.6 N.m with flat Ø 3.5 mm screwdriver
Product weight	0.405 kg

Environment

Max immunity to microbreaks	5 ms
Dielectric strength	2000 V conforming to IEC 60947-1
IP degree of protection	IP2x conforming to IEC 60529
Resistance to incandescent wire	750 °C, extinction time <30 s conforming to IEC 60695-2-11
Vibration resistance	2 gn (f= 10...150 Hz) conforming to IEC 60068-2-6
Resistance to electrostatic discharge	4 kV (contact) level 3 conforming to IEC 61000-4-2 8 kV (air) level 3 conforming to IEC 61000-4-2
Resistance to radiated fields	10 V/m (26000000...1000000000 Hz) conforming to IEC 61000-4-3 level 3
Resistance to fast transients	2 kV level 3 conforming to IEC 61000-4-4
Ambient air temperature for operation	-5...60 °C conforming to IEC 61131-2
Ambient air temperature for storage	-40...80 °C conforming to IEC 61131-2
Pollution degree	2 conforming to IEC 60664-1

Packing Units

Package 1 Weight	0.532 kg
Package 1 Height	0.700 dm
Package 1 width	0.830 dm
Package 1 Length	2.110 dm

Offer Sustainability

Sustainable offer status	Green Premium product
REACH Regulation	REACH Declaration
EU RoHS Directive	Pro-active compliance (Product out of EU RoHS legal scope) EU RoHS Declaration
Mercury free	Yes
RoHS exemption information	Yes
China RoHS Regulation	China RoHS declaration
Environmental Disclosure	Product Environmental Profile
Circularity Profile	End of Life Information
WEEE	The product must be disposed on European Union markets following specific waste collection and never end up in rubbish bins

Contractual warranty

Warranty	18 months
----------	-----------

Dimensions

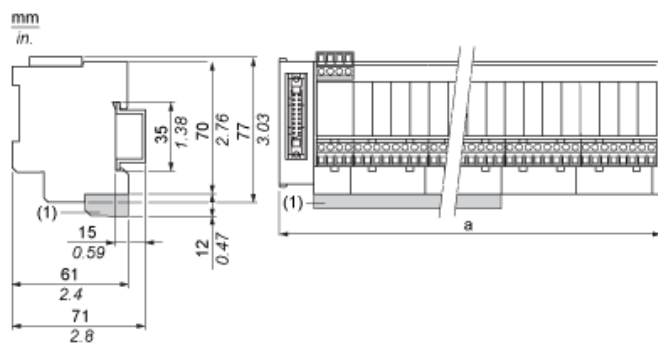

(1) ABE7BV20 / ABE7BV20E

ABE7	a in mm	a in in.
R16S111 / R16S111E	125	4.92
R16S21 / R16S21•E	206	8.11

Mounting

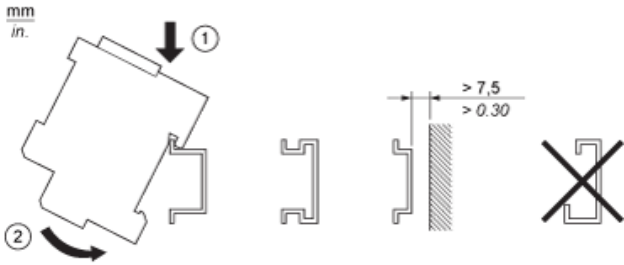

HE10 16 Channels

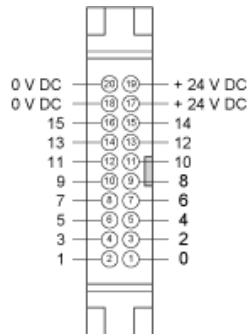

Wiring Diagram

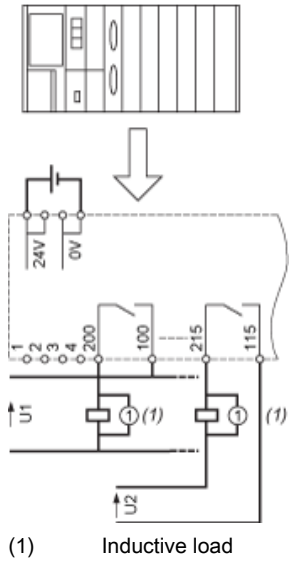

Curves for Determining Cable Type and Length According to the Current

16-channel Sub-base

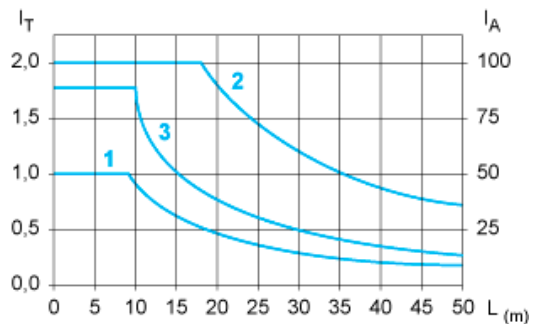

L Cable length

I_T Total current per sub base (A)

I_A Average current per channel (mA)

(1) TSXCDP••2 and ABFH20H••0 cables with c.s.a. 0.08 mm^2 (AWG 28).

(2) TSXCDP••3 cables with c.s.a. 0.34 mm^2 (AWG 22).

(3) Cables with c.s.a. 0.13 mm^2 (AWG 26).

The curves are given for a voltage drop of 1 V in the cable. For n volts tolerance, multiply the length determined from the graph by n.

Electrical Durability (in Millions of Operating Cycles) Conforming to IEC 60947-5-1

DC Loads

DC12 curves

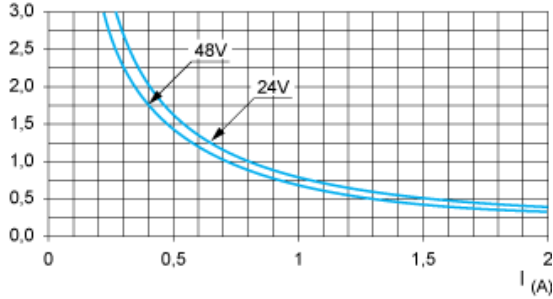

DC12 control of resistive loads and of solid state loads isolated by optocoupler, $I/R \leq 1$ ms.

DC13 curves

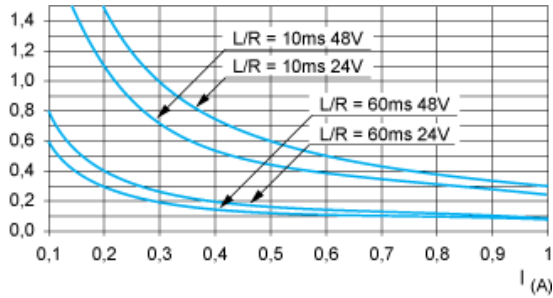

DC13 switching electromagnets, $L/R \leq 2 \times (U_e \times I_e)$ in ms, U_e : rated operational voltage, I_e : rated operational current (with a protective diode on the load, DC)

AC Loads

AC12 curves

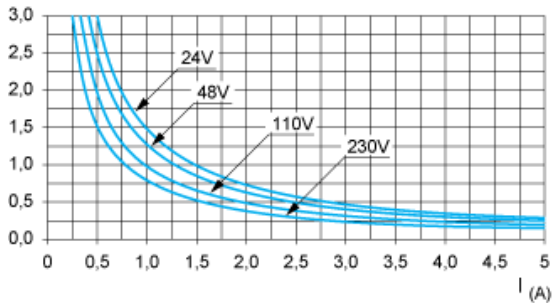

AC12 control of resistive loads and of solid state loads isolated by optocoupler, $\cos \phi \geq 0.9$.

AC14 curves

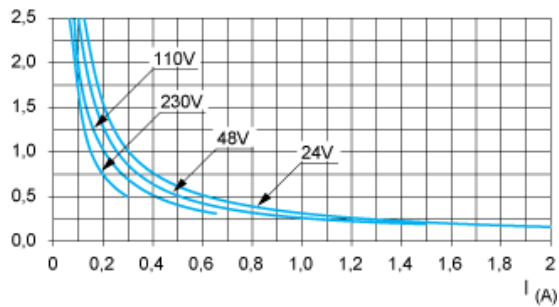

AC14 control of small electromagnetic loads ≤ 72 VA, make: $\cos \phi = 0.3$, break: $\cos \phi = 0.3$.

AC15 curves

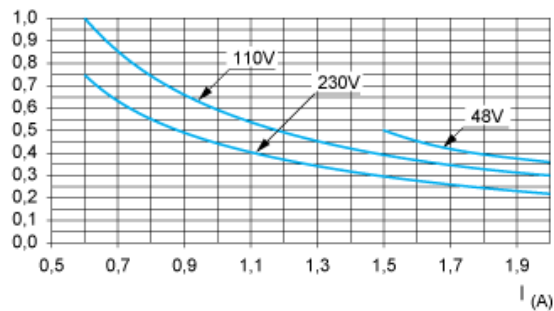

AC15 control of electromagnetic loads > 72 VA, make: $\cos \phi = 0.7$, break: $\cos \phi = 0.4$.

ABE7R16S210E is replaced by:

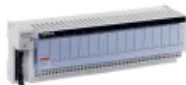

Interfaces for PLCs ABE7R16S210

sub-base - soldered electromechanical relays ABE7 - 16 channels - relay 10 mm

Qty 1