

Product datasheet

Specifications



variable speed drive ATV12 -
0.55kW - 0.75hp - 200..240V - 1ph -
with heat sink

TSI Code: 392951579 ATV12H055M2

Main

Product destination	Asynchronous motors
Component name	ATV12
Built-in fan	Without
Network number of phases	1 phase
Motor power kW	0.55 kW
Motor power hp	0.75 hp
Line current	8 A at 200 V 6.7 A at 240 V
Speed range	1...20
IP degree of protection	IP20 without blanking plate on upper part
Range of product	Altivar 12
Product or component type	Variable speed drive
Product specific application	Simple machine
Communication port protocol	Modbus
[Us] rated supply voltage	200...240 V - 15...10 %
EMC filter	Integrated

Complementary

Supply frequency	50/60 Hz +/- 5 %
Connector type	1 RJ45 (on front face) for Modbus
Physical interface	2-wire RS 485 for Modbus
Transmission frame	RTU for Modbus
Transmission rate	4800 bit/s 9600 bit/s 19200 bit/s 38400 bit/s
Number of addresses	1...247 for Modbus
Communication service	Read holding registers (03) 29 words Write single register (06) 29 words Write multiple registers (16) 27 words Read/write multiple registers (23) 4/4 words Read device identification (43)
Continuous output current	3.5 A at 4 kHz

Maximum transient current	5.3 A for 60 s
Speed drive output frequency	0.5...400 Hz
Braking torque	Up to 70 % of nominal motor torque without braking resistor
Output voltage	200...240 V 3 phases
Electrical connection	Terminal, clamping capacity: 3.5 mm ² , AWG 12 (L1, L2, L3, U, V, W, PA, PC)
Tightening torque	0.8 N.m
Insulation	Electrical between power and control
Supply	Internal supply for reference potentiometer: 5 V DC (4.75...5.25 V), <10 mA, protection type: overload and short-circuit protection Internal supply for logic inputs: 24 V DC (20.4...28.8 V), <100 mA, protection type: overload and short-circuit protection
Analogue input type	Configurable current AI1 0...20 mA 250 Ohm Configurable voltage AI1 0...10 V 30 kOhm Configurable voltage AI1 0...5 V 30 kOhm
Discrete input type	Programmable LI1...LI4 24 V 18...30 V
Discrete input logic	Negative logic (sink), > 16 V (state 0), < 10 V (state 1), input impedance 3.5 kOhm Positive logic (source), 0...< 5 V (state 0), > 11 V (state 1)
Sampling duration	20 ms, tolerance +/- 1 ms for logic input 10 ms for analogue input
Linearity error	+/- 0.3 % of maximum value for analogue input
Analogue output type	AO1 software-configurable voltage: 0...10 V, impedance: 470 Ohm, resolution 8 bits AO1 software-configurable current: 0...20 mA, impedance: 800 Ohm, resolution 8 bits
Discrete output type	Logic output LO+, LO- Protected relay output R1A, R1B, R1C 1 C/O
Minimum switching current	5 mA at 24 V DC for logic relay
Maximum switching current	2 A 250 V AC inductive cos phi = 0.4 L/R = 7 ms logic relay 2 A 30 V DC inductive cos phi = 0.4 L/R = 7 ms logic relay 3 A 250 V AC resistive cos phi = 1 L/R = 0 ms logic relay 4 A 30 V DC resistive cos phi = 1 L/R = 0 ms logic relay
Braking to standstill	By DC injection, <30 s
Frequency resolution	Analog input: converter A/D, 10 bits Display unit: 0.1 Hz
Time constant	20 ms +/- 1 ms for reference change
Functionality	Basic
Specific application	Commercial equipment
Variable speed drive application selection	Mixer Commercial equipment Other application Commercial equipment Ironing Textile
Motor starter type	Variable speed drive
Discrete input number	4
Discrete output number	2
Analogue input number	1
Analogue output number	1
Asynchronous motor control profile	Voltage/frequency ratio (V/f) Quadratic voltage/frequency ratio Sensorless flux vector control
Transient overtorque	150...170 % of nominal motor torque depending on drive rating and type of motor
Acceleration and deceleration ramps	Linear from 0 to 999.9 s S U
Motor slip compensation	Preset in factory Adjustable
Switching frequency	2...16 kHz adjustable 4...16 kHz with derating factor

Nominal switching frequency	4 kHz
Prospective line I_{sc}	1 kA
Protection type	Line supply overvoltage Line supply undervoltage Overcurrent between output phases and earth Overheating protection Short-circuit between motor phases Against input phase loss in three-phase Thermal motor protection via the drive by continuous calculation of I ² t
Quantity per set	Set of 1
Width	72 mm
Height	143 mm
Depth	131.2 mm
Product weight	0.8 kg

Environment

Electromagnetic emission	Radiated emissions environment 1 category C2 conforming to EN/IEC 61800-3 2...16 kHz shielded motor cable Conducted emissions with integrated EMC filter environment 1 category C1 conforming to EN/IEC 61800-3 2, 4, 8, 12 and 16 kHz shielded motor cable <5 m Conducted emissions with integrated EMC filter environment 1 category C2 conforming to EN/IEC 61800-3 2...12 kHz shielded motor cable <5 m Conducted emissions with integrated EMC filter environment 1 category C2 conforming to EN/IEC 61800-3 2, 4 and 16 kHz shielded motor cable <10 m Conducted emissions with additional EMC filter environment 1 category C1 conforming to EN/IEC 61800-3 4...12 kHz shielded motor cable <20 m Conducted emissions with additional EMC filter environment 1 category C2 conforming to EN/IEC 61800-3 4...12 kHz shielded motor cable <50 m Conducted emissions with additional EMC filter environment 2 category C3 conforming to EN/IEC 61800-3 4...12 kHz shielded motor cable <50 m
Vibration resistance	1 gn (f = 13...200 Hz) conforming to EN/IEC 60068-2-6 1.5 mm peak to peak (f = 3...13 Hz) - drive unmounted on symmetrical DIN rail - conforming to EN/IEC 60068-2-6
Shock resistance	15 gn conforming to EN/IEC 60068-2-27 for 11 ms
Relative humidity	5...95 % without condensation conforming to IEC 60068-2-3 5...95 % without dripping water conforming to IEC 60068-2-3
Ambient air temperature for operation	-10...40 °C protective cover from the top of the drive removed 40...60 °C with current derating 2.2 % per °C
Operating altitude	> 1000...2000 m with current derating 1 % per 100 m <= 1000 m without derating
Operating position	Vertical +/- 10 degree
Product certifications	C-Tick NOM GOST CSA UL
Marking	CE
Assembly style	With heat sink
Electromagnetic compatibility	Electrical fast transient/burst immunity test level 4 conforming to EN/IEC 61000-4-4 Electrostatic discharge immunity test level 3 conforming to EN/IEC 61000-4-2 Immunity to conducted disturbances level 3 conforming to EN/IEC 61000-4-6 Radiated radio-frequency electromagnetic field immunity test level 3 conforming to EN/IEC 61000-4-3 Surge immunity test level 3 conforming to EN/IEC 61000-4-5 Voltage dips and interruptions immunity test conforming to EN/IEC 61000-4-11
Noise level	0 dB
Ambient air temperature for storage	-25...70 °C

Packing Units

Unit Type of Package 1	PCE
Number of Units in Package 1	1
Package 1 Weight	1.118 kg

Package 1 Height	10.6 cm
Package 1 width	18.6 cm
Package 1 Length	18.6 cm
Unit Type of Package 2	P06
Number of Units in Package 2	45
Package 2 Weight	63.31 kg
Package 2 Height	73.5 cm
Package 2 width	60 cm
Package 2 Length	80 cm

Offer Sustainability

Sustainable offer status	Green Premium product
REACH Regulation	REACH Declaration
EU RoHS Directive	Pro-active compliance (Product out of EU RoHS legal scope) EU RoHS Declaration
Mercury free	Yes
RoHS exemption information	Yes
China RoHS Regulation	China RoHS declaration
Environmental Disclosure	Product Environmental Profile
Circularity Profile	End of Life Information
WEEE	The product must be disposed on European Union markets following specific waste collection and never end up in rubbish bins

Contractual warranty

Warranty	18 months
----------	-----------

Dimensions

Drive without EMC Conformity Kit

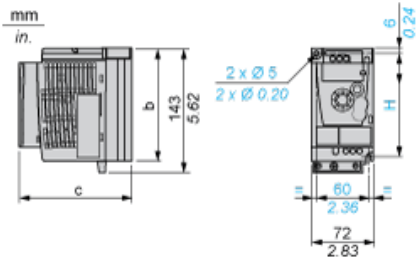

Dimensions in mm

b	c	H
130	131.2	120

Dimensions in in.

b	c	H
5.12	5.16	4.72

Drive with EMC Conformity Kit

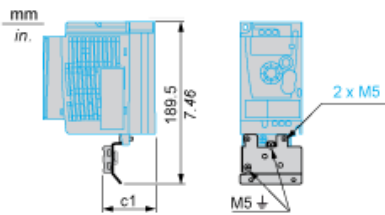

Dimensions in mm

c1
63

Dimensions in in.

c1
2.48

Mounting Recommendations

Clearance for Vertical Mounting

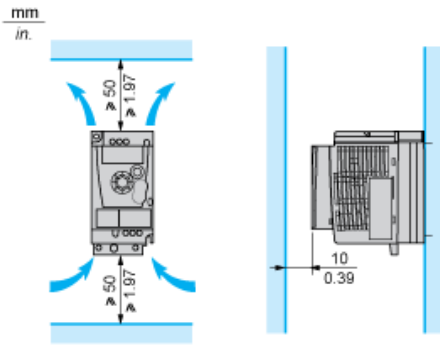

Mounting Type A

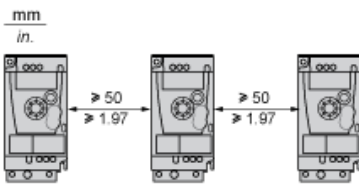

Mounting Type B

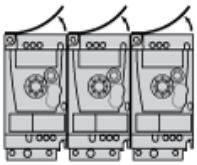

Remove the protective cover from the top of the drive.

Mounting Type C

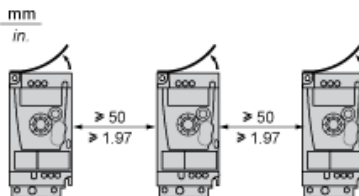

Remove the protective cover from the top of the drive.

Single-Phase Power Supply Wiring Diagram

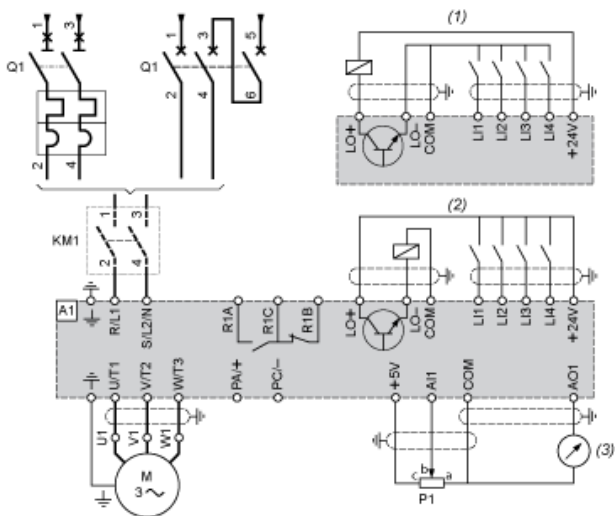

- A1** Drive
- KM1** Contactor (only if a control circuit is needed)
- P1** 2.2 kΩ reference potentiometer. This can be replaced by a 10 kΩ potentiometer (maximum).
- Q1** Circuit breaker
- (1)** Negative logic (Sink)
- (2)** Positive logic (Source) (factory set configuration)
- (3)** 0...10 V or 0...20 mA

Recommended Schemes

2-Wire Control for Logic I/O with Internal Power Supply

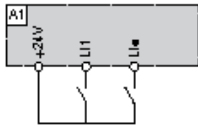

LI1 : Forward
LIe : Reverse
A1 : Drive

3-Wire Control for Logic I/O with Internal Power Supply

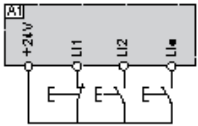

LI1 : Stop
LI2 : Forward
LIe : Reverse
A1 : Drive

Analog Input Configured for Voltage with Internal Power Supply

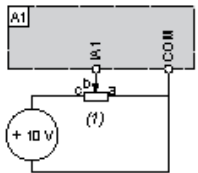

(1) 2.2 kΩ...10 kΩ reference potentiometer
A1 : Drive

Analog Input Configured for Current with Internal Power Supply

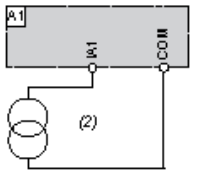

(2) 0-20 mA 4-20 mA supply
A1 : Drive

Connected as Positive Logic (Source) with External 24 vdc Supply

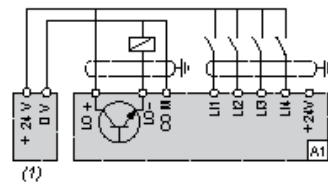

(1) 24 vdc supply
A1 : Drive

Connected as Negative Logic (Sink) with External 24 vdc supply

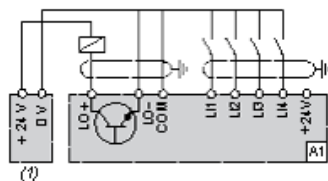

(1) 24 vdc supply
A1 : Drive

Torque Curves

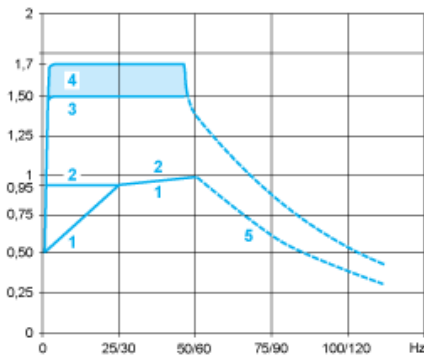

- 1 : Self-cooled motor: continuous useful torque (1)
- 2 : Force-cooled motor: continuous useful torque
- 3 : Transient overtorque for 60 s
- 4 : Transient overtorque for 2 s
- 5 : Torque in overspeed at constant power (2)
- (1) For power ratings ≤ 250 W, derating is 20% instead of 50% at very low frequencies.
- (2) The nominal motor frequency and the maximum output frequency can be adjusted from 0.5 to 400 Hz. The mechanical overspeed capability of the motor is 150%.