



Main

| | |
|---------------------------|------------------|
| Range | TeSys |
| Product name | TeSys GV2 |
| Device short name | GV2P |
| Product or component type | Circuit breaker |
| Device application | Motor |
| Trip unit technology | Thermal-magnetic |

Complementary

| | |
|---|--|
| Poles description | 3P |
| Network type | AC |
| Utilisation category | AC-3 conforming to IEC 60947-4-1 Category A conforming to IEC 60947-2 |
| Network frequency | 50/60 Hz conforming to IEC 60947-4-1 |
| Fixing mode | Clipped on 35 mm symmetrical DIN rail Screwed on panel (with 2 x M4 screws) |
| Operating position | Any position |
| Motor power kW | 3 kW at 400/415 V AC 50/60 Hz 5 kW at 500 V AC 50/60 Hz 5.5 kW at 690 V AC 50/60 Hz |
| Breaking capacity | 50 kA Icu at 500 V AC 50/60 Hz conforming to IEC 60947-2 100 kA Icu at 230/240 V AC 50/60 Hz conforming to IEC 60947-2 100 kA Icu at 400/415 V AC 50/60 Hz conforming to IEC 60947-2 100 kA Icu at 440 V AC 50/60 Hz conforming to IEC 60947-2 6 kA Icu at 690 V AC 50/60 Hz conforming to IEC 60947-2 |
| [Ics] rated service short-circuit breaking capacity | 100 % at 230/240 V AC 50/60 Hz conforming to IEC 60947-2 100 % at 440 V AC 50/60 Hz conforming to IEC 60947-2 100 % at 500 V AC 50/60 Hz conforming to IEC 60947-2 100 % at 690 V AC 50/60 Hz conforming to IEC 60947-2 100 % at 400/415 V AC 50/60 Hz conforming to IEC 60947-2 |
| Control type | Rotary knob |
| [In] rated current | 10 A |

Disclaimer: This documentation is not intended as a substitute for and is not to be used for determining suitability or reliability of these products for specific user applications

| | |
|---|---|
| Thermal protection adjustment range | 6...10 A |
| Magnetic tripping current | 138 A |
| [Ue] rated operational voltage | 690 V AC 50/60 Hz conforming to IEC 60947-2 |
| [Ui] rated insulation voltage | 690 V AC 50/60 Hz conforming to IEC 60947-2 |
| [Ith] conventional free air thermal current | 10 A conforming to IEC 60947-4-1 |
| [Uimp] rated impulse withstand voltage | 6 kV conforming to IEC 60947-2 |
| Power dissipation per pole | 2.5 W |
| Mechanical durability | 100000 cycles |
| Electrical durability | 100000 cycles for AC-3 at 440 V |
| Operating rate | 25 cyc/h |
| Rated duty | Continuous conforming to IEC 60947-4-1 |
| Connections - terminals | Screw clamp terminals 2 cable(s) 1...6 mm ² solid Screw clamp terminals 2 cable(s) 1.5...6 mm ² flexible without cable end Screw clamp terminals 2 cable(s) 1...4 mm ² flexible with cable end |
| Tightening torque | 1.7 N.m on screw clamp terminals |
| Suitability for isolation | Yes conforming to IEC 60947-1 |
| Phase failure sensitivity | Yes conforming to IEC 60947-4-1 |
| Height | 89 mm |
| Width | 45 mm |
| Depth | 97 mm |

Environment

| | |
|---------------------------------------|---|
| Standards | CSA C22.2 NF C 63-120 NF C 63-650 IEC 60947-4-1 IEC 60947-2 EN 60204 IEC 60947-1 UL 508 NF C 79-130 VDE 0660 VDE 0113 |
| Product certifications | EZU GL CCC ATEX DNV RINA BV LROS (Lloyds register of shipping) UL 508 type E CSA EAC TSE UL |
| Protective treatment | TH |
| IP degree of protection | IP20 conforming to IEC 60529 |
| IK degree of protection | IK04 |
| Ambient air temperature for operation | -20...60 °C |
| Ambient air temperature for storage | -40...80 °C |
| Fire resistance | 960 °C conforming to IEC 60695-2-1 |
| Operating altitude | 2000 m |

Offer Sustainability

| | |
|--------------------------|---|
| Sustainable offer status | Green Premium product |
| RoHS (date code: YYWW) | Compliant - since 0631 - Schneider Electric declaration of conformity Schneider Electric declaration of conformity |
| REACH | Reference contains SVHC above the threshold - Go to CaP for more details |

 [Go to CaP for more details](#)

| | |
|-------------------------------|---|
| Product environmental profile | Available |
| |  Product Environmental Profile |

| | |
|----------------------------------|---------------------------------------|
| Product end of life instructions | Need no specific recycling operations |
|----------------------------------|---------------------------------------|

Contractual warranty

| | |
|-----------------|-----------|
| Warranty period | 18 months |
|-----------------|-----------|

Thermal-Magnetic Tripping Curves for GV2ME and GV2P

Average Operating Times at 20 °C Related to Multiples of the Setting Current



- 1 3 poles from cold state
- 2 2 poles from cold state
- 3 3 poles from hot state

Current Limitation on Short-Circuit for GV2ME and GV2P (3-Phase 400/415 V))

Dynamic Stress

$I_{peak} = f(\text{prospective } I_{sc}) \text{ at } 1.05 U_e = 435 \text{ V}$

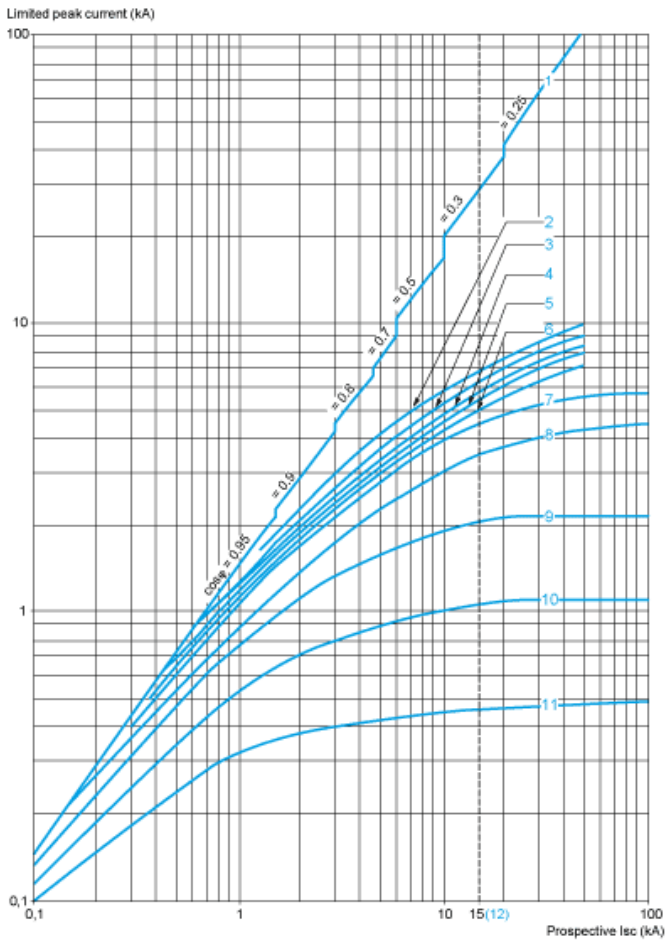

- 1 Maximum peak current
- 2 24-32 A
- 3 20-25 A
- 4 17-23 A
- 5 13-18 A
- 6 9-14 A
- 7 6-10 A
- 8 4-6.3 A
- 9 2.5-4 A
- 10 1.6-2.5 A
- 11 1-1.6 A
- 12 Limit of rated ultimate breaking capacity on short-circuit of GV2ME (14, 18, 23, and 25 A ratings).

Thermal Limit on Short-Circuit for GV2P

Thermal Limit in kA^2s in the Magnetic Operating Zone

Sum of $I^2dt = f$ (prospective I_{sc}) at $1.05 U_e = 435 V$

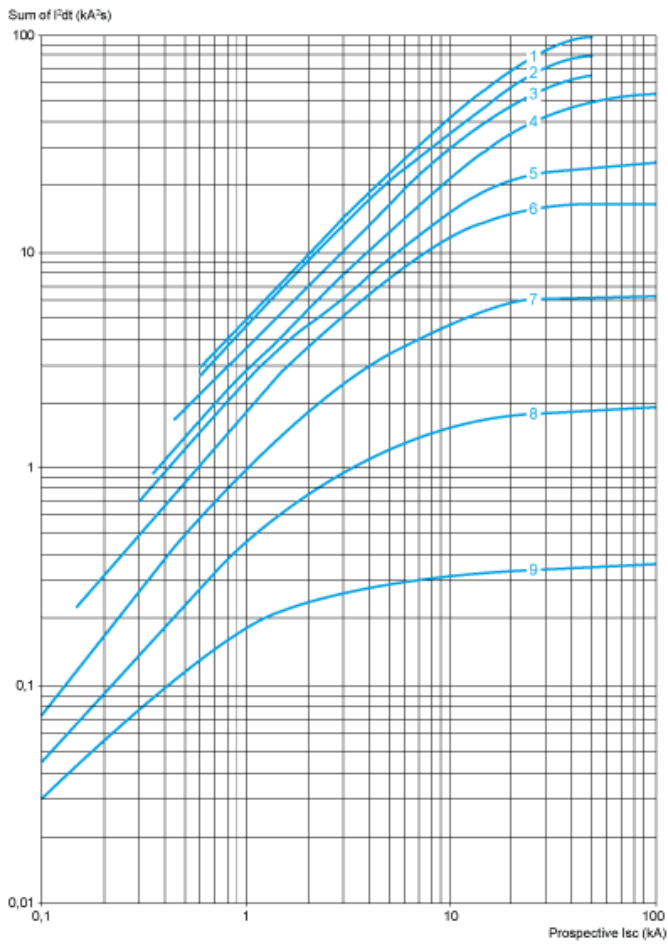

- | | |
|----|-----------|
| 1 | 24-32 A |
| 2 | 20-25 A |
| 3 | 17-23 A |
| 4 | 13-18 A |
| 5 | 9-14 A |
| 6 | 6-10 A |
| 7 | 4-6.3 A |
| 8 | 2.5-4 A |
| 9 | 1.6-2.5 A |
| 10 | 1-1.6 A |

GV2P

On rail AM1 DE200, ED200 (35 x 15)

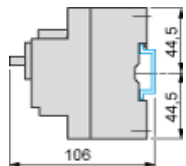

Panel mounted

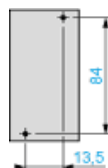

On pre-slotted plate AM1 PA

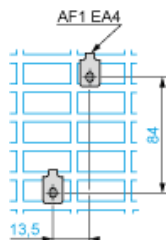

Adapter plate GK2AF01

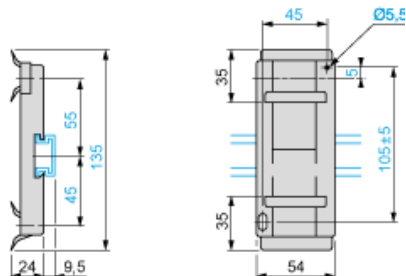

Combination GV2P + TeSys d contactor

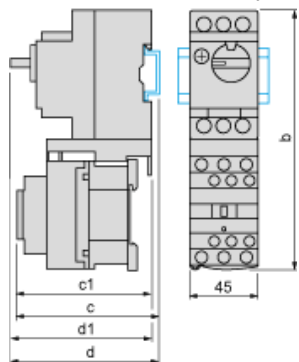

| GV2P + | LC1D09...D18 | LC1D25 and D32 |
|--------|--------------|----------------|
| b | 176.4 | 186.8 |
| c1 | 100.1 | 106.4 |

| | | |
|--------|--------------|----------------|
| GV2P + | LC1D09...D18 | LC1D25 and D32 |
| c | 105.6 | 111.9 |
| d1 | 95 | 95 |
| d | 100.5 | 100.5 |

Mounting

Mounting of External Operator GV2APN01, GV2APN02 or GV2APN04 for Motor Circuit Breakers GV2P

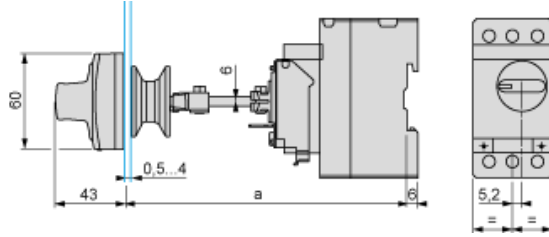

Door cut-out

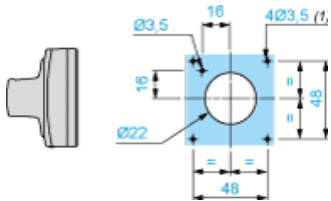

(1) For IP65 only.

Mounting of External Operator GVAPH02 for Motor Circuit Breakers GV2P

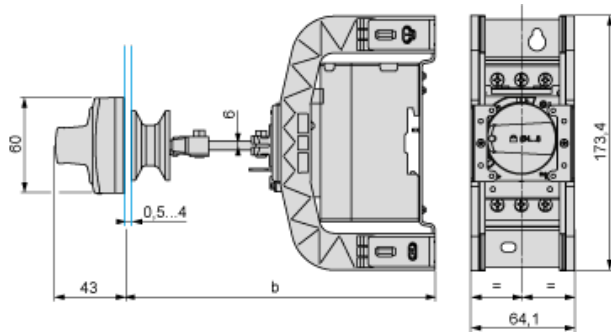

| | a | | b | |
|------------------------------|---------|---------|---------|---------|
| | Minimum | Maximum | Minimum | Maximum |
| GV2APN.. | 140 | 250 | – | – |
| GV2APN.. + GVAPH02 | – | – | 151 | 250 |
| GV2APN.. + GVAPK11 | 250 | 434 | – | – |
| GV2APN.. + GVAPH02 + GVAPK11 | – | – | 250 | 445 |

Door cut-out

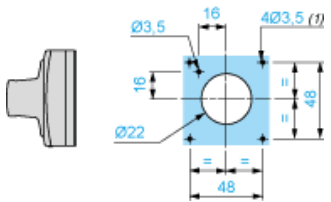

(1) For IP65 only.

GV2P••

